

## **ASSEMBLY INSTRUCTIONS FOR 12' GOAL**

### **1. READ THE INCLUDED SAFETY INSTRUCTIONS**

2. Unpack all parts and check against parts list.
3. Slide 14 standoffs in top and bottom rail approx. 12" apart. See figure 1.
4. Slide 6 standoffs in 67" right and left posts approx. 12" apart. See figure 1.
5. Slide 6 standoffs in 73" right and left bases approx. 12" apart. See figure 1.
6. Attach top corners to top rail with 3/8" x 7/8" socket head bolts, 3/8" lock washers, & 3/8" flat washers. See figure 2.
7. Insert right and left 67" posts into top corners. Attach with 3/8" x 7/8" socket head bolts, 3/8" lock washers, & 3/8" flat washers. See figure 3.
8. Attach back corners to back rail with 3/8" x 7/8" socket head bolts, 3/8" lock washers, & 3/8" flat washers. See figure 4.
9. Insert right and left 73" bases into back corners. Attach with 3/8" x 7/8" socket head bolts, 3/8" lock washers, & 3/8" flat washers. See figure 5.
10. Insert front corners into 73" bases. Attach with 3/8" x 7/8" socket head bolts, 3/8" lock washers, & 3/8" flat washers. See figure 6.
11. Loosely attach the front corner brackets to base using 3/8" x 1 1/4" socket head bolts, 3/8" lock washers, 3/8" flat washers, and 3/8" square nuts. Square nut can be inserted from top of base. See figure 6 detail.
12. Attach back hoops to right and left posts using 3/8" x 1 1/4" socket head bolts, 3/8" lock washers, 3/8" flat washers, and 3/8" square nuts. Square nut can be inserted from top of post. See figure 7.
13. Fasten back hoop braces to hoops with 3/8" x 1 3/4" socket head bolts, 3/8" flat washers, and 3/8" lock nuts. Install 5/16" x 2" eyebolt, 5/16" flat washer and 5/16" locknut into hoop. See figure 8.
14. Attach back hoop braces to top rail with 3/8" x 1 1/4" socket head bolts, 3/8" lock washers, 3/8" flat washers, and 3/8" square nuts. Square nut can be inserted from top of rail. See figure 8.
15. Stand up assembled base and slide corners into posts. Attach with 3/8" x 7/8" socket head bolts, 3/8" lock washers, & 3/8" flat washers. See figure 9.
16. Attach front corner brackets to front posts with 3/8" x 1 1/4" socket head bolts, 3/8" lock washers, 3/8" flat washers, and 3/8" square nuts. Square nut can be inserted from top of post. See figure 10.
17. Attach ground anchor plates (2) to the back rail with 3/8" x 1 1/2" socket head bolts, 3/8" lock washers, 3/8" flat washers, and 3/8" square nuts. Square nut can be inserted from top of rail. See figure 11.
18. Attach net to standoffs.

**SAFETY INSTRUCTIONS AS PER ASTM F-2056-00:**

ALL GOALS WHEN NOT IN USE SHALL BE SECURED AGAINST OVER TURNING AS PER ASTM F 2056-00

ALWAYS CHECK FOR STRUCTURAL INTEGRITY AND PROPER CONNECTING HARDWARE BEFORE EVERY USE. REPLACE DAMAGED OR MISSING PARTS OR FASTENERS IMMEDIATELY.

ENSURE SAFETY/WARNING LABELS ARE CLEARLY VISIBLE (PLACED UNDER THE CROSS BAR AND ON THE SIDES OF THE DOWN-POSTS AT EYE LEVEL).

SECURELY ANCHOR OR COUNTERWEIGHT MOVABLE GOALS AT ALL TIMES.

ALWAYS INSTRUCT PLAYERS, MANAGERS, COACHES, TRAINERS, TEACHERS, MAINTENANCE AND ALL OTHER PERSONNEL WHO MIGHT COME INTO CONTACT WITH THE GOAL ON SAFE HANDLING AND POTENTIAL DANGERS ASSOCIATED WITH MOVABLE SOCCER GOALS.

ALWAYS EXERCISE EXTREME CAUTION WHEN MOVING GOALS AND ALLOW ADEQUATE MANPOWER TO MOVE GOALS OF VARIED SIZES AND WEIGHTS. MOVABLE SOCCER GOALS SHOULD ONLY BE MOVED BY AUTHORIZED OR TRAINED PERSONNEL.

NEVER ALLOW ANYONE TO CLIMB ON THE NET OR GOAL FRAMEWORK.

MOVABLE SOCCER GOALS SHOULD ONLY BE USED ON LEVEL FIELDS, NEVER ON A SLOPE OR HILL AREA.

REMOVE NETS WHEN GOALS ARE NOT IN USE.

MOST OF THE TIPOVER INJURIES OCCURRED WHEN GOALS WERE UNATTENDED. ANCHOR OR CHAIN ONE GOAL TO ANOTHER, TO ITSELF IN A FOLDED DOWN POSITION, OR TO NEARBY FENCE POSTS, DUGOUTS, OR ANY OTHER SIMILAR STURDY FIXTURE WHEN NOT IN USE. IF THIS IS NOT PRACTICAL, STORE MOVABLE SOCCER GOALS IN A PLACE WHERE CHILDREN CANNOT HAVE ACCESS TO THEM.

FULLY DISASSEMBLE GOALS FOR SEASONAL STORAGE.

### **PARTS LIST FOR 24' GOAL**

<u>QTY</u>	<u>DESCRIPTION</u>
1	Top Rail
1	Back Rail
1	Left Post
1	Right Post
1	Left Base
1	Right Base
4	Corners
2	Front Post Corners
2	Corner Brackets
2	Back Hoop
2	Back Hoop Brace
2	Ground Anchor
52	Standoff

### **HARDWARE FOR GOAL**

<u>QTY</u>	<u>DESCRIPTION</u>
24	3/8" x 7/8" Socket head bolt
10	3/8" x 1 1/4" Socket head bolt
2	3/8" x 1 1/2" Socket head bolt
2	3/8" x 1 3/4" Socket head bolt
40	3/8" Lock washer
40	3/8" Flat washer
12	3/8" Square nut
2	5/16" x 2" Eye bolt
2	5/16" Flat washer
2	5/16" Lock nut

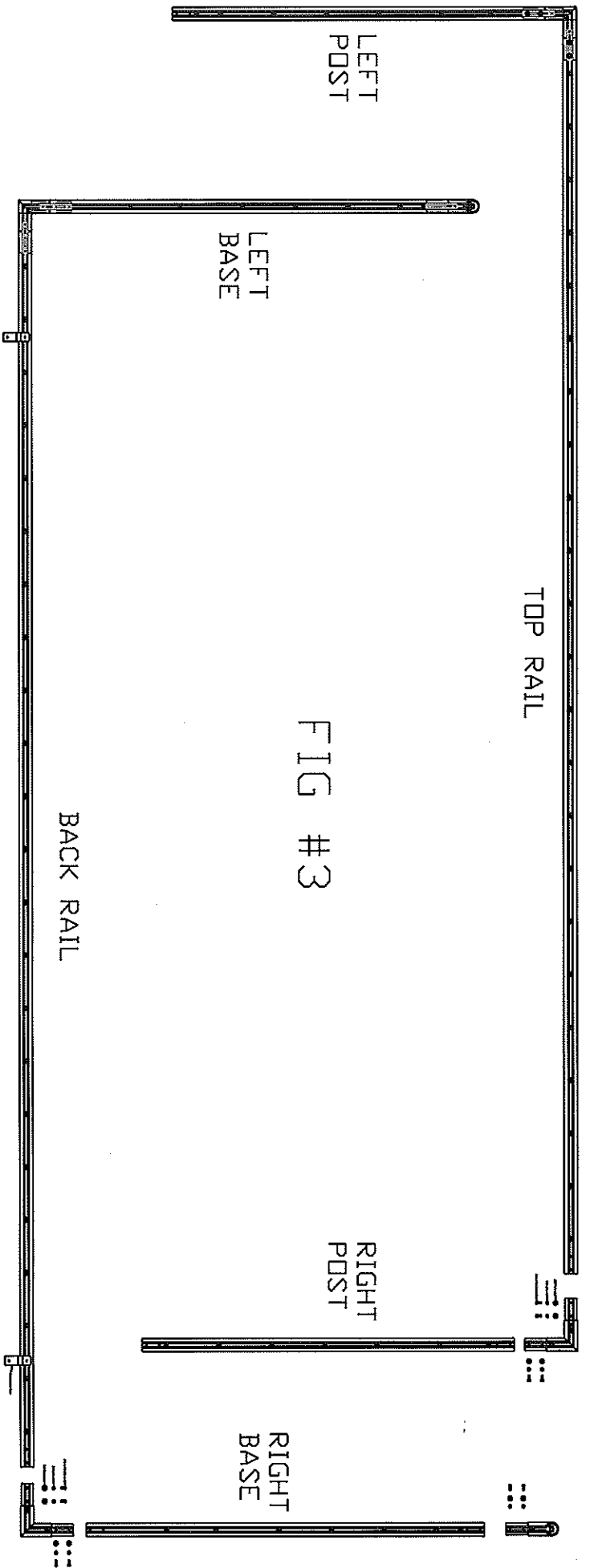

FIG #3

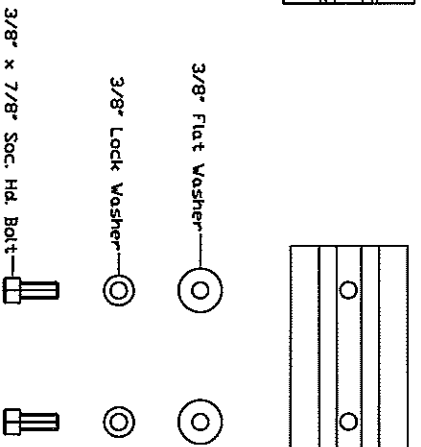

FIG #2

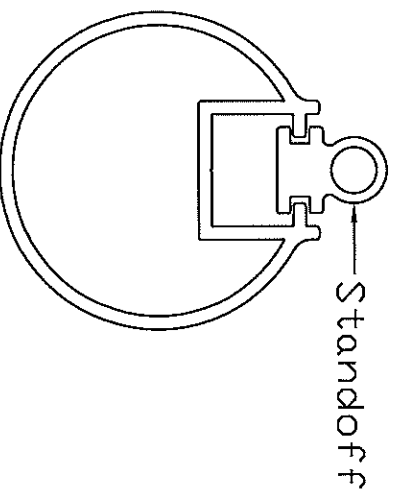

FIG #1

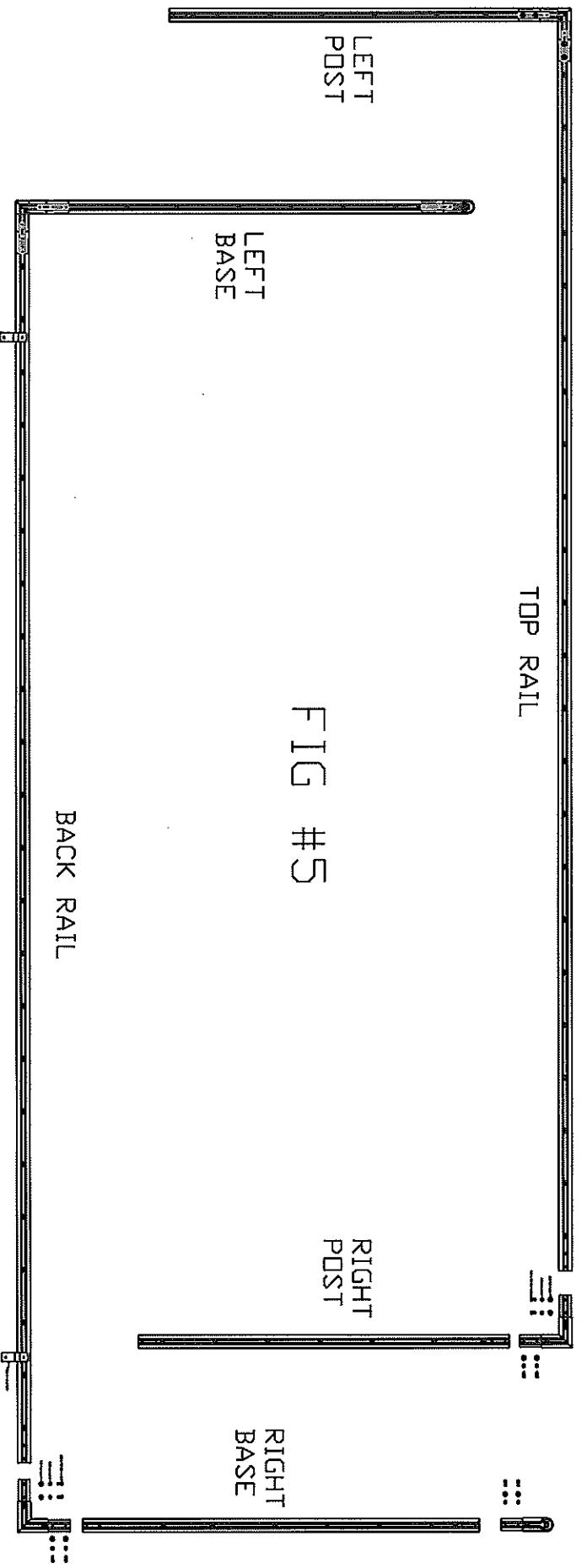
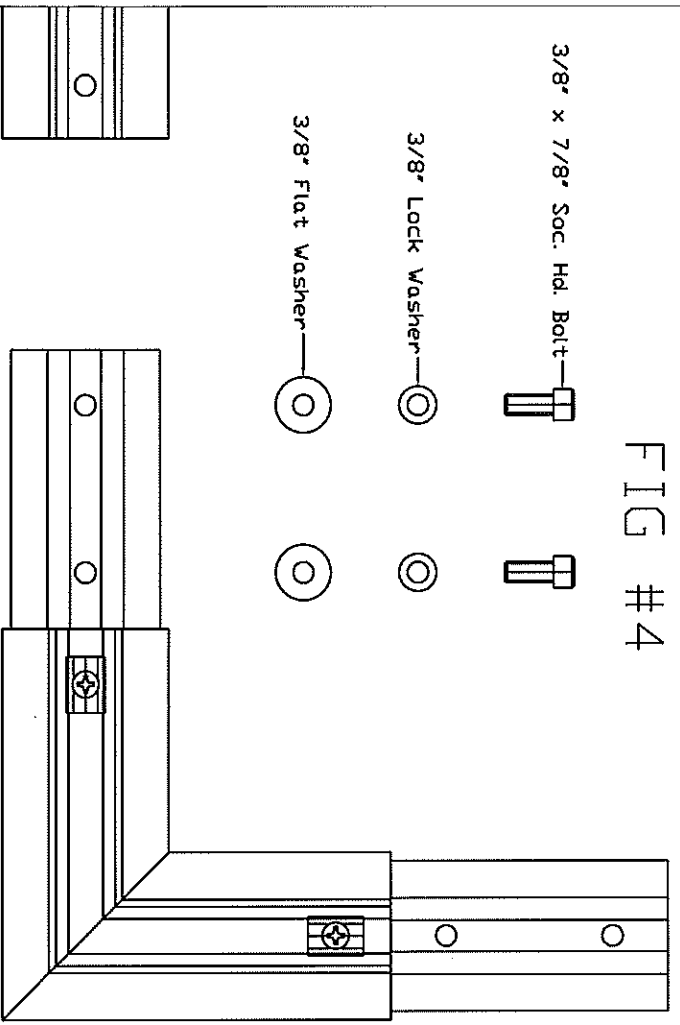

FIG #5

FIG #4



3/8" x 7/8" Soc. Hd. Bolt

3/8" Lock Washer

3/8" Flat Washer

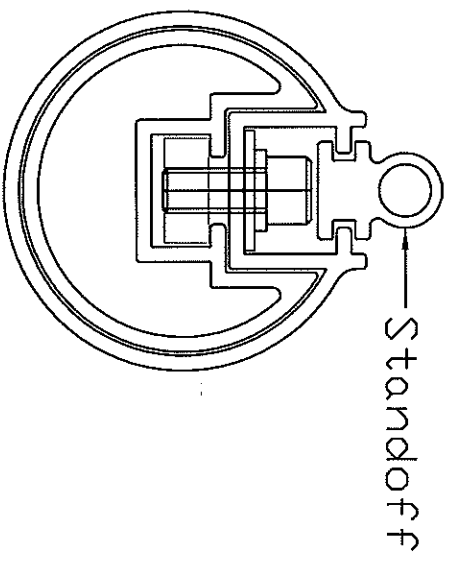
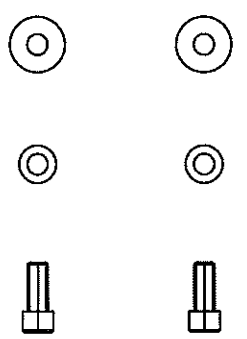

3/8 X 7/8 SDC HD  
BOLT  
DETAIL

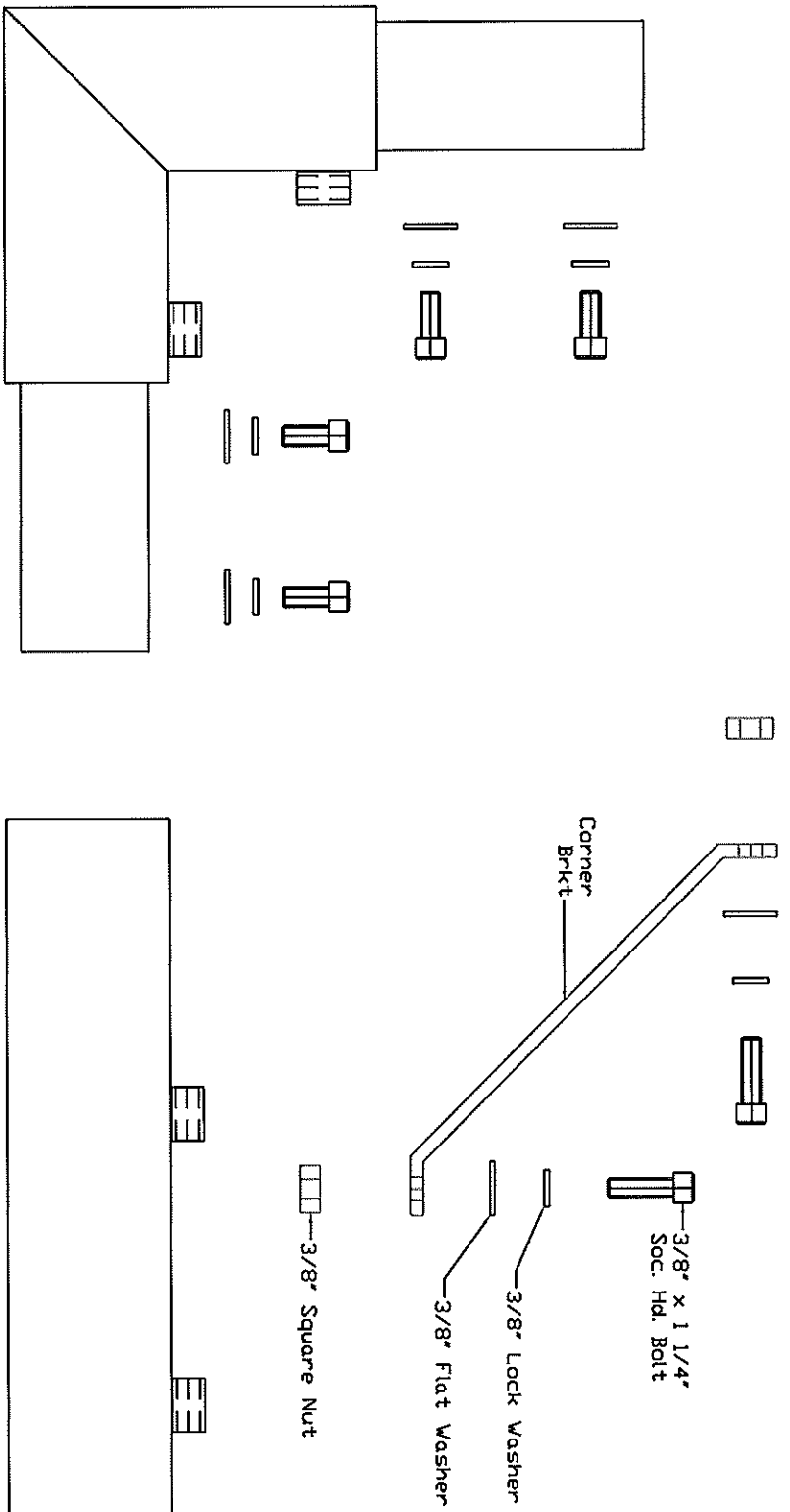

FIG #6

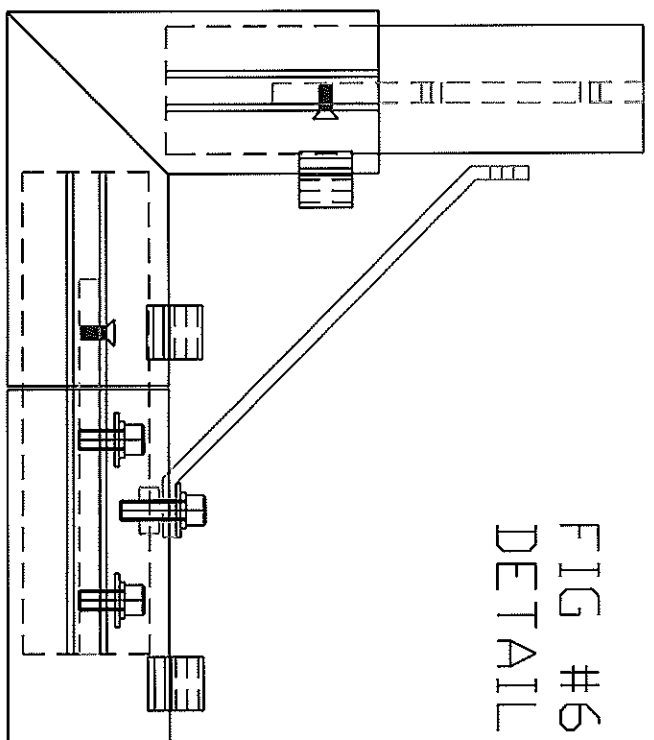
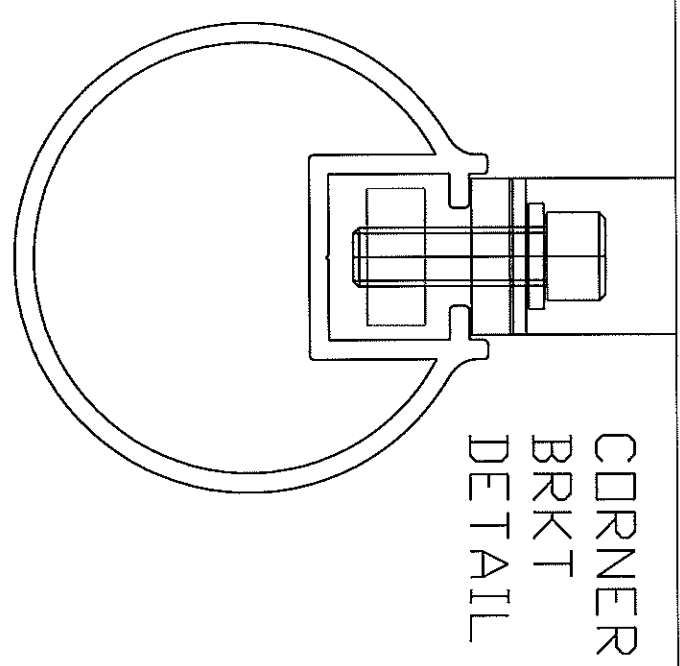
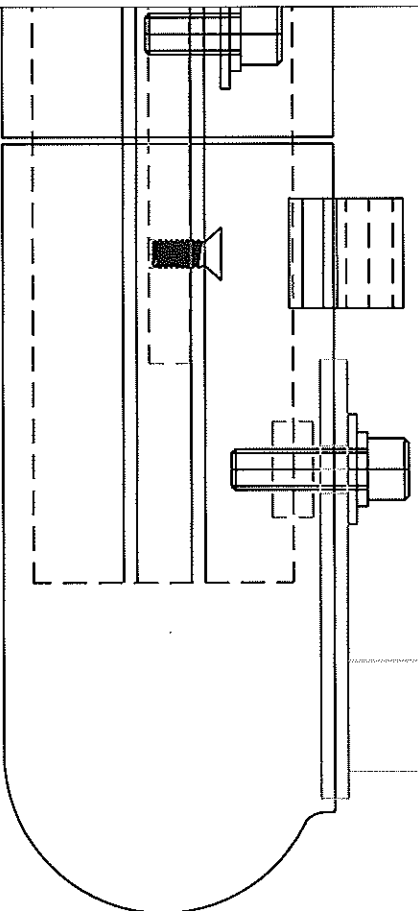
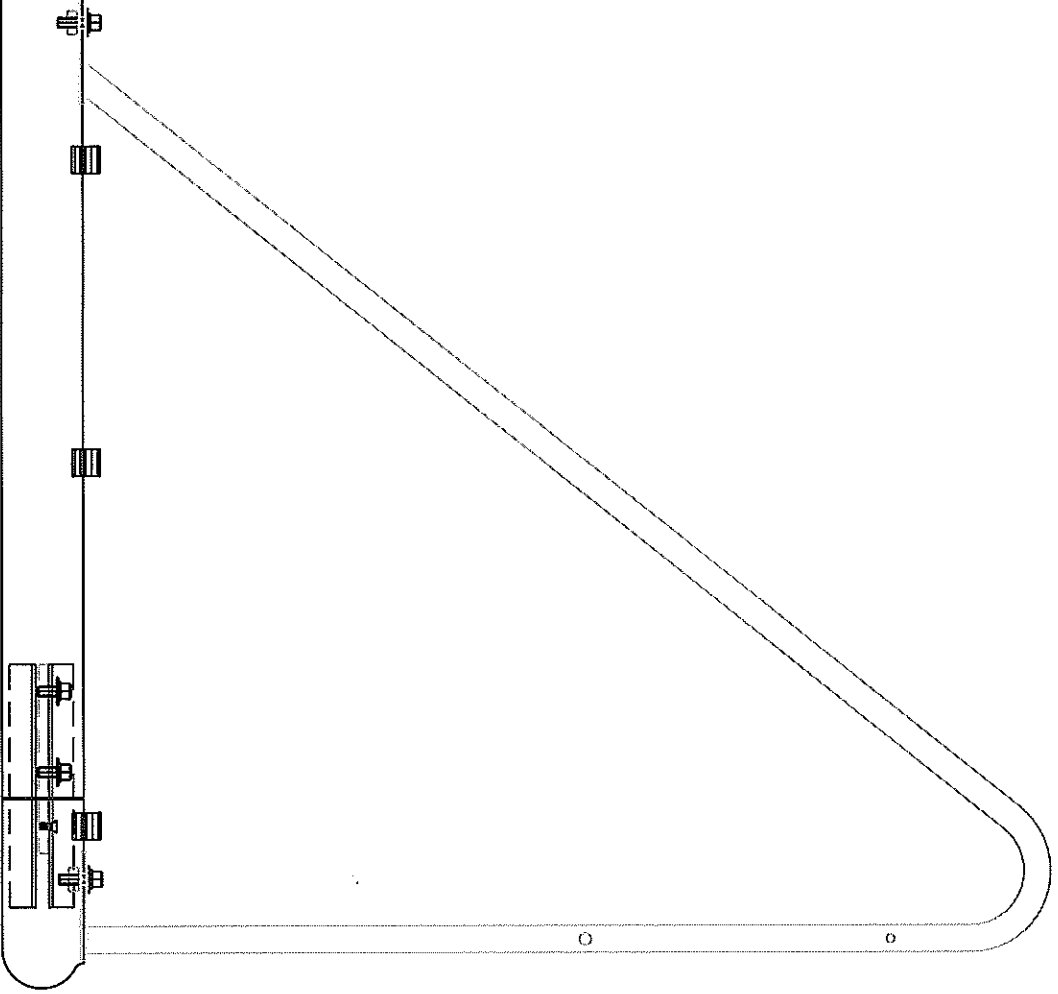

FIG #6  
DETAIL



CORNER  
BRKT  
DETAIL

FIG #7



3/8" x 1 1/4"  
Soc. Hd. Bolt



3/8" Lock Washer

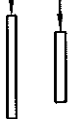

3/8" Flat Washer



3/8" Square Nut

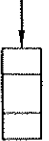

FIG #8

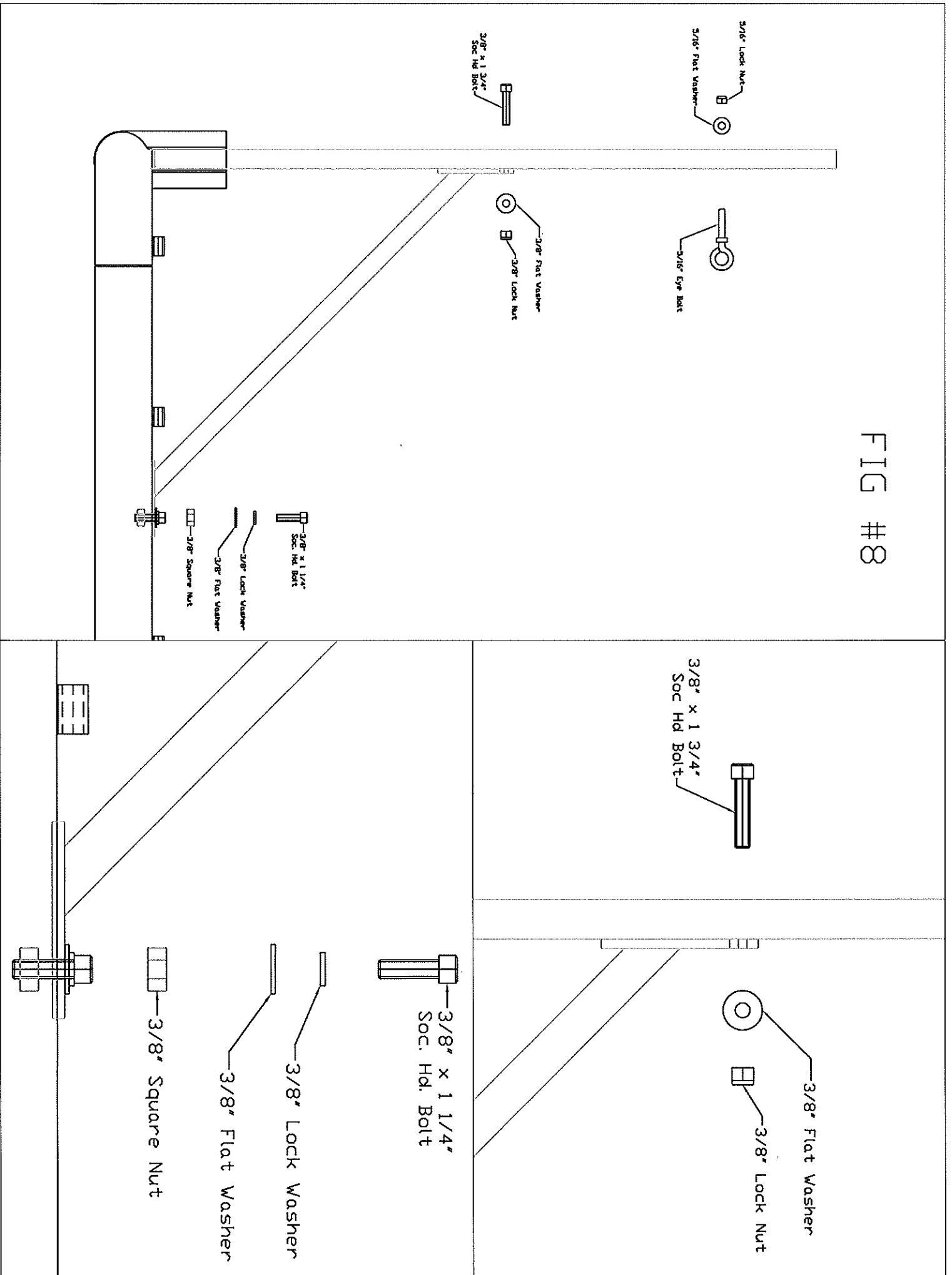

FIG #9

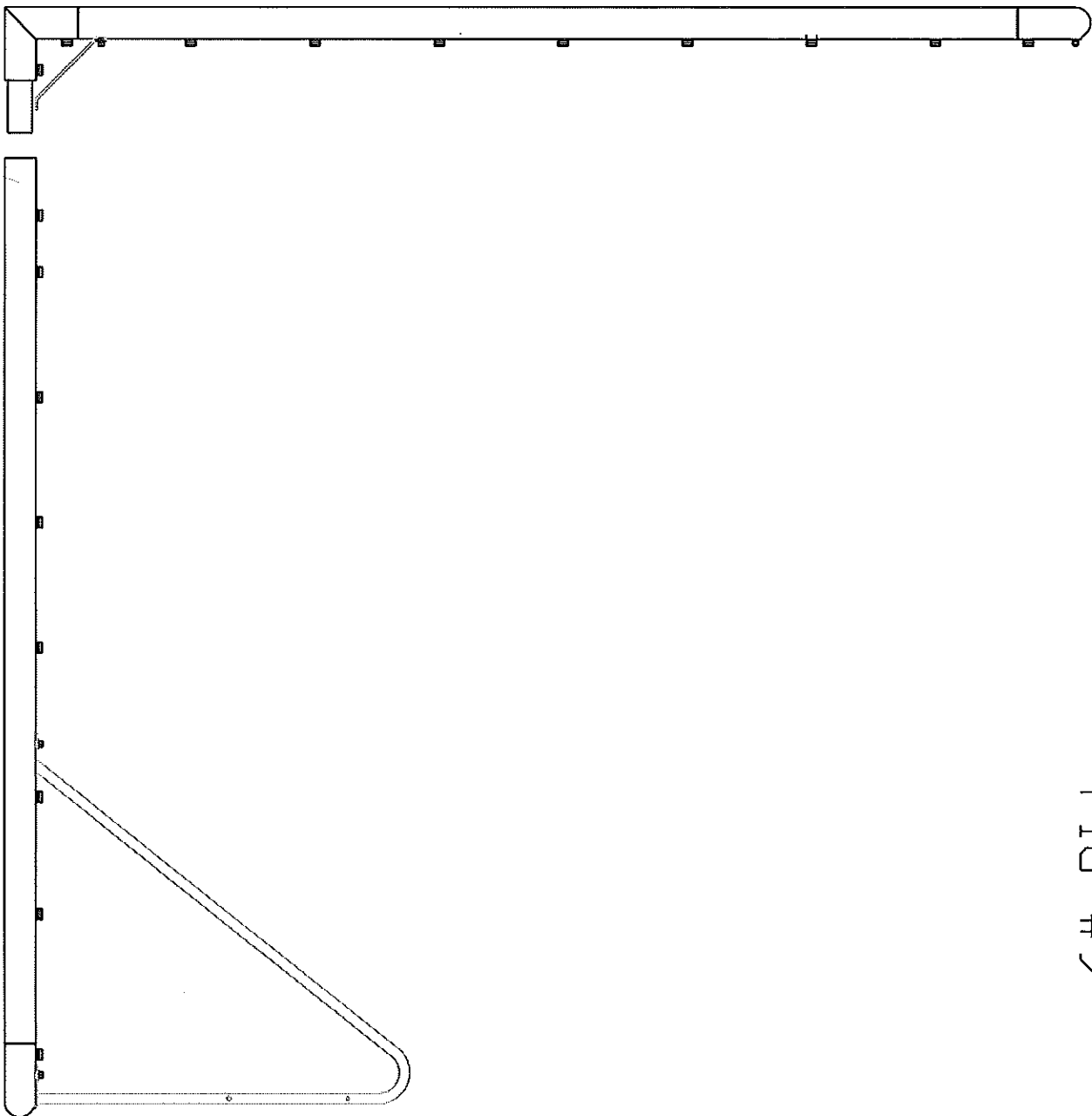
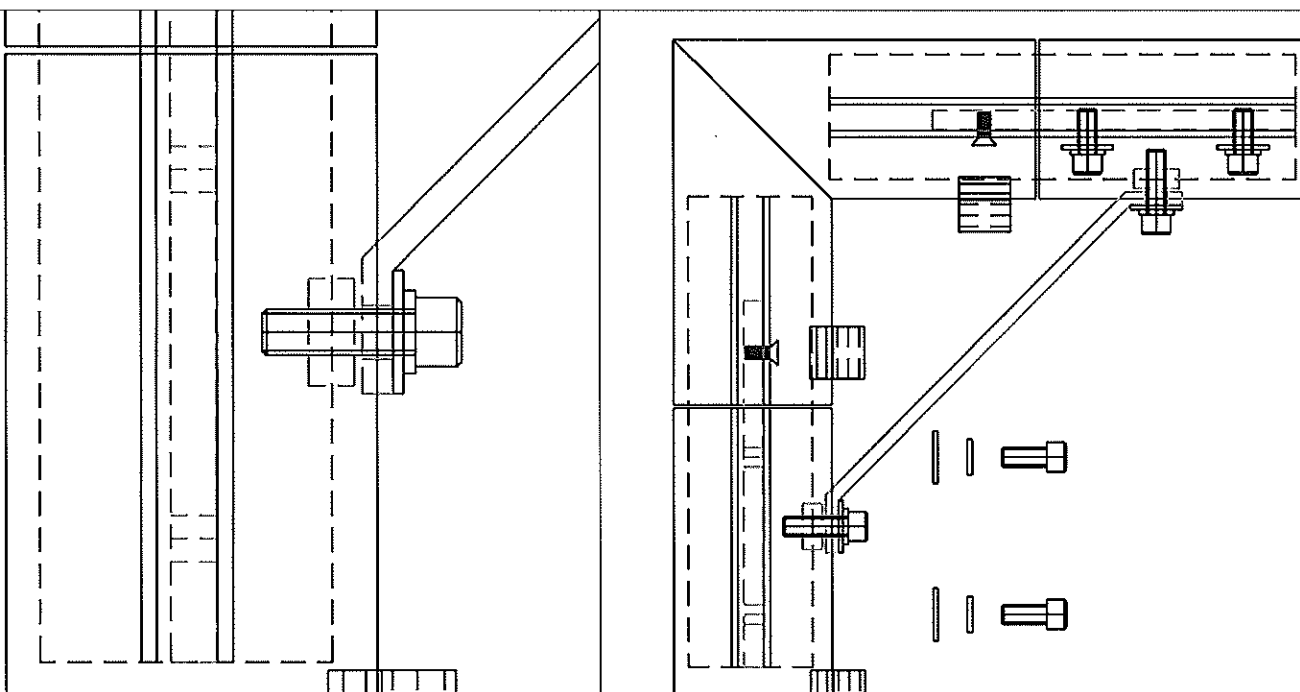
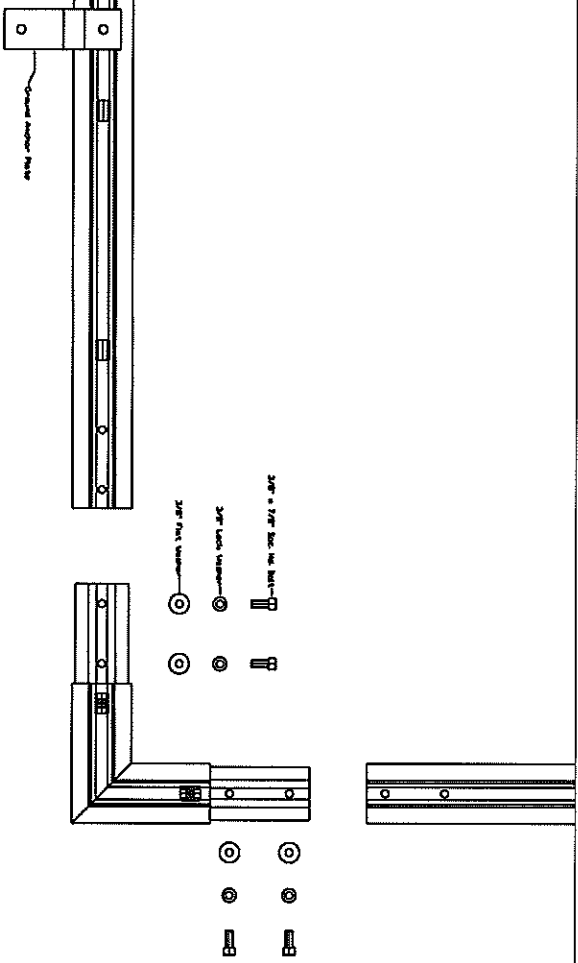
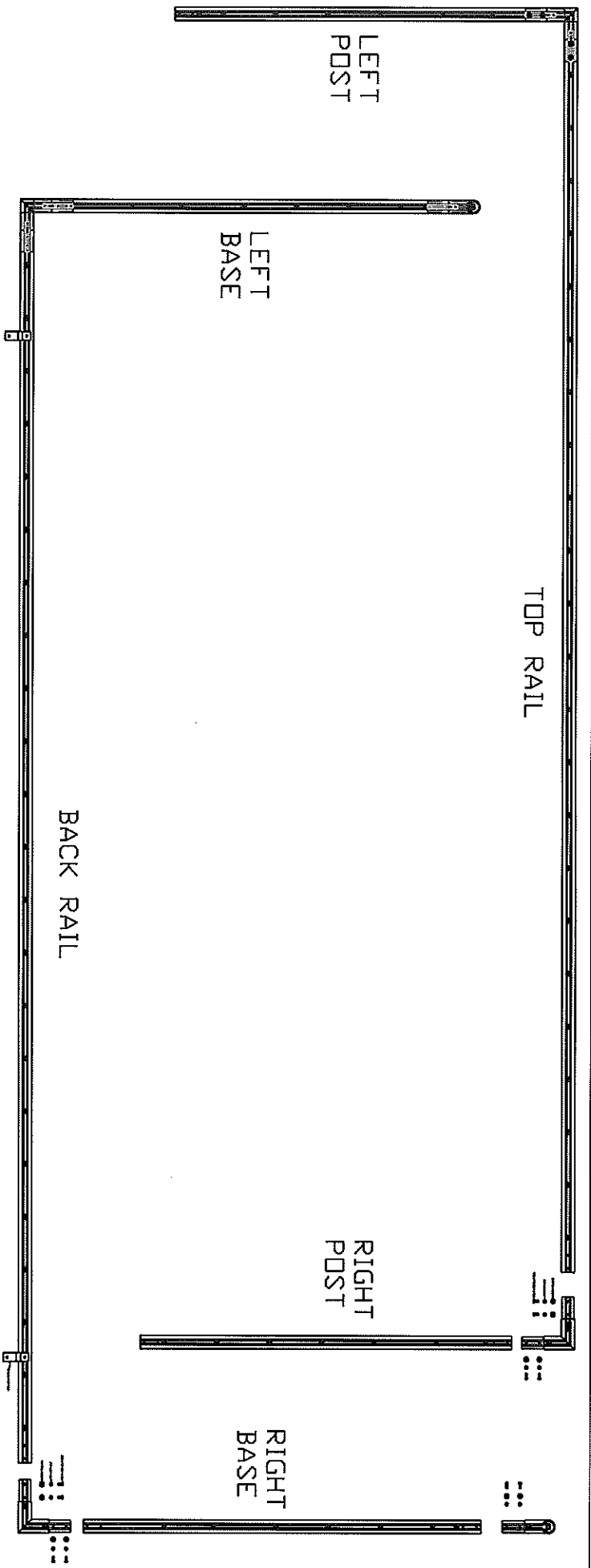

FIG #10





BACK RAIL

3/8" x 1 1/2" Soc. Hd. Bolt

3/8" Lock Washer

3/8" Flat Washer

3/8" Square Nut

Ground Anchor Plate

FIG #11

